

# DEDICATED POWDER TOOLS GUIDE

## for SINTERIT SLS 3D PRINTER

Version 09/2020

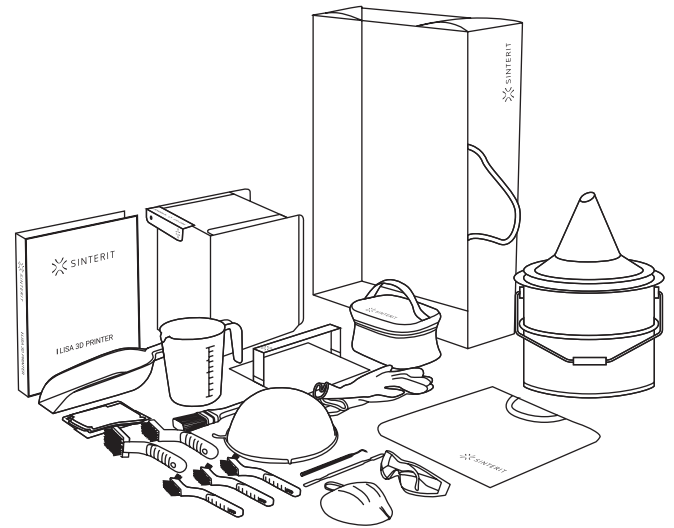

### A STARTUP BOX

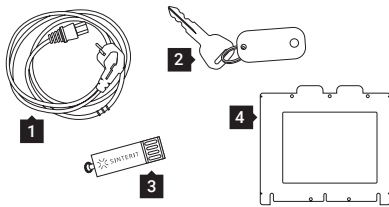

1.Power cable / 2.Ignition key / 3.USB flash drive /  
4.Laser Protective Glass

### B PERSONAL PROTECTION

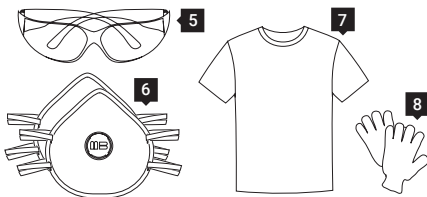

5.Protective Glasses / 6.Protective Dust Mask /  
7.T-shirt / 8.Protective Gloves

### C POWDER MANAGEMENT TOOLS

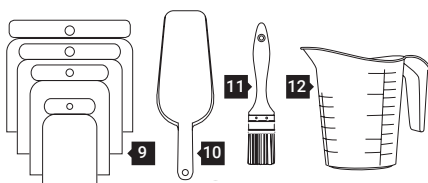

9.Scrapers / 10.Scoop / 11.Brush / 12.Measuring cup

### D POST PROCESSING TOOLS

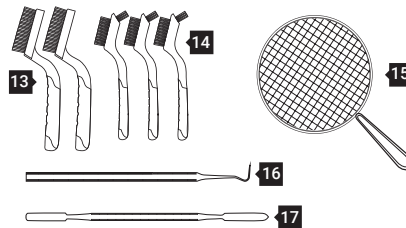

13.Large brushes / 14.Small brushes / 15.Metal strainer /  
16.Stainless steel probe / 17.Metal spatula

### E SERVICE KIT

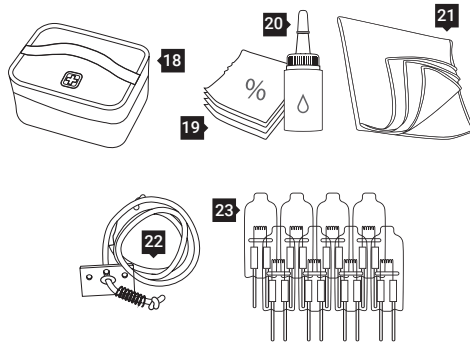

18.Trunk / 19.Alcohol pads / 20.Silicone oil / 21.Cotton cloth /  
22.Spare recoaters cords / 23.Infrared heaters

### F POWDER TOOLS

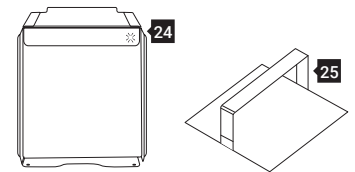

24.IO box / 25.Powder trowel

### G POWDER FUNNEL

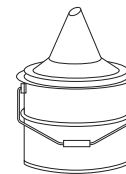

### H FOLDABLE TRAY

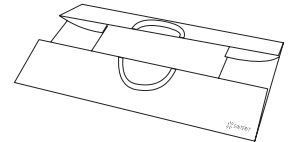

### I BINDER

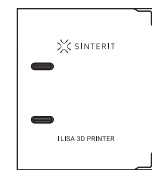

All the equipment needed for the whole printing process, from the initial startup to post processing and maintenance, is attached in five boxes described below.

**A Startup box.** All you need to turn on the printer for the first time. In case of LISA PRO printer – Startup box is placed in lower part of the printer. In case of LISA printer – Startup box is placed on the top of device.

**B Personal protection.** When handling with powder, always wear safety gloves, glasses and anti-dust mask that we included in this set.

**C Powder management tools.** Everything required to fill the printer with powder and manage the powder.

**D Post processing tools.** To help you clean your printout out of the powder residues.

**E Service kit.** Just like any other device – your printer needs some cleaning, lubrication and replacement parts from time to time. Just in case, keep it within easy reach.

**F Powder Tools.** IO box + Powder trowel - tools designed to help you fill the printer and take out the printouts.

**G Powder Funnel.** For easier control of the poured powder stream. Nothing falls outside the work area. No loss, no mess.

**H Foldable Tray.** Your movable working space to deal with powder and to keep the process clean.

contact us if you have any questions  
+48 570 702 886  
support@sinterit.com

SINTERIT Sp. z o.o.  
ul. Nad Drwina 10 bud. B3, 30-741 Krakow  
www.sinterit.com